

# SUNRICH

— E N E R G Y —



## LiFePO<sub>4</sub> Battery User Manual

Model: SE-B100

Thank you very much for choosing SUNRICH ENERGY lithium iron battery!  
In order to help you use, store and maintain the lithium battery of our company,  
please read and understand this user manual carefully before use.



02	IMPORTANT NOTES
02	EXPLANATION OF SYMBOLS
03	SAFETY INSTRUCTIONS
04	SCOPE OF DELIVERY
05	TARGET GROUP
05	INTENDED USE
06	TECHNICAL DESCRIPTION
07	INSTALLATION
08	CONFIGURATION
10	CLEANING
11	STORAGE
11	TROUBLESHOOTING
12	DISPOSAL
13	TECHNICAL DATA
17	AFTER-SALE SERVICE

# IMPORTANT NOTES

---

Please read these instructions carefully and follow all instructions, guidelines, and warnings included in this product manual in order to ensure that you install, use, and maintain the product properly at all times. These instructions **MUST** stay with this product.

By using the product, you hereby confirm that you have read all instructions, guidelines, and warnings carefully and that you understand and agree to abide by the terms and conditions as set forth herein. You agree to use this product only for the intended purpose and application and in accordance with the instructions, guidelines, and warnings as set forth in this product manual as well as in accordance with all applicable laws and regulations. A failure to read and follow the instructions and warnings set forth herein may result in an injury to yourself and others, damage to your product or damage to other property in the vicinity. This product manual, including the instructions, guidelines, and warnings, and related documentation, may be subject to changes and updates. For up-to-date product information, please visit [www.sunrichenergy.com](http://www.sunrichenergy.com).

# EXPLANATION OF SYMBOLS

---

## **WARNING!**

Indicates a hazardous situation that, if not avoided, will result in death or serious injury.

## **CAUTION!**

Indicates a hazardous situation that, if not avoided, could result in minor or moderate injury.

## **NOTICE!**

Indicates a hazardous situation that, if not avoided, could result in minor or moderate injury.

 **Note:** Supplementary information for operating the product.

# SAFETY INSTRUCTIONS

---

## **WARNING! RISK OF INJURY**

- Batteries contain aggressive and caustic acids. Avoid battery fluid coming into contact with your body. If your skin does come into contact with battery fluid, wash that part of your body thoroughly with water. If you sustain any injuries from acids, contact a doctor immediately.
- When working on batteries, do not wear any metal objects such as watches or rings. LiFePO<sub>4</sub> batteries can cause short circuits which can cause serious injuries.
- Only use insulated tools.
- Do not place any metal parts on the battery.
- Wear goggles and protective clothing when working on batteries. Do not touch your eyes when working on batteries.
- Do not use defective batteries.

## **WARNING! HEALTH HAZARD**

Keep the battery out of the reach of children.

## **CAUTION! ELECTROCUTION HAZARD**

- Keep the battery away from water.
- Avoid short circuits.
- Avoid clothing rubbing against the battery.
- Wear antistatic clothing when handling the battery.

## **CAUTION! EXPLOSION HAZARD**

- Do not place the battery in a area with flammable liquids or gases.
- Never attempt to charge a frozen or defective battery. Place the battery in a frost-free area and wait until the battery has acclimatised to the ambient temperature. Then start the charging process.
- Do not smoke, use an open flame, or cause sparking near the engine or a battery.
- Keep the battery away from heat sources.

## NOTICE! DAMAGE HAZARD

- Only use rechargeable batteries.
- Prevent any metal parts from falling on the battery. This can cause sparks or short-circuit the battery and other electrical parts.
- Ensure that the polarity is correct when connecting the battery.
- Follow the instructions of the battery manufacturer and those of the manufacturer of the system or vehicle in which the battery is used.
- If the battery has to be removed, first disconnect the ground connection. Disconnect all connections and all consumers from the battery before removing it.
- Recharge stored batteries regularly.
- Do not carry the battery by its terminals.

## SAFETY PRECAUTIONS WHEN HANDLING LITHIUM BATTERIES

### CAUTION! RISK OF INJURY

Only use batteries with integrated battery management system and cell balancing.

### NOTICE! DAMAGE HAZARD

Avoid deep discharge of the batteries.

## SCOPE OF DELIVERY

ITEM	Name	Specifications	Unit	QTY	Remark
1	Battery	12.8V100Ah (SE-B100)	Set	1	
2	Screw	SUS304_M8x12_triple combination machine tooth screw	PCS	2	PE bag packaging
3	Screw	SUS304_M8x16_triple combination machine tooth screw	PCS	2	PE bag packaging
4	Screw	SUS304_M8x20_triple combination machine tooth screw	PCS	2	PE bag packaging
5	Manual	LiFePO <sub>4</sub> Battery User Manual	PCS	1	PE bag packaging

## TARGET GROUP

---

The electrical power supply must be connected by a qualified electrician who has demonstrated skill and knowledge related to the construction and operation of electrical equipment and installations, and who is familiar with the applicable regulations of the country in which the equipment is to be installed and / or used, and has received safety training to identify and avoid the hazards involved.

## INTENDED USE

---

The device is intended to be used as a storage of electrical power for motorhomes, RVs, camping. This product is only suitable for the intended purpose and application in accordance with these instructions.

This manual provides information that is necessary for proper installation and/or operation of the product. Poor installation and / or improper operating or maintenance will result in unsatisfactory performance and a possible failure.

The manufacturer accepts no liability for any injury or damage to the product resulting from:

- Incorrect assembly or connection, including excess voltage.
- Incorrect maintenance or use of spare parts other than original spare parts provided by the manufacturer.
- Alterations to the product without express permission from the manufacturer.
- Use for purposes other than those described in this manual.

SUNRICH reserves the right to change product appearance and product specifications.

# TECHNICAL DESCRIPTION

---

The advanced LiFePO<sub>4</sub> battery offers the desired features like charging below freezing. The batteries are equipped with a Battery Management System (BMS) which is built in the battery housing. The battery management system can be used to prevent deep discharge, overcharge, and over-temperature of the battery. This battery has the following features:

## HEATING FUNCTION

When it's active: If the battery's charging protection system detects low temperatures, the heating function automatically turns on, but only when there is charging current present. The battery cannot use its own internal power to activate the heater. When it turns off: Once the temperature rises above the set threshold, the heating function will automatically turn off.

There is a heater inside the battery. The heater is controlled by a BMS, allowing the battery to be charged at low temperatures.

Heat the Opening Temperature	≤28.4°F
Heating Opening Conditions	Charge
Heating closing Conditions	Disconnect the charger or Temperature ≥37.4°F
Heating Power	100W

(Temperature refers to the temperature detected by the internal temperature probe of the battery, not the ambient temperature.)

# INSTALLATION

The SE-B100 battery has the following components:

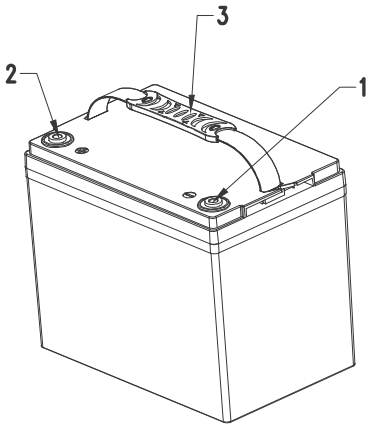

1. Negative battery terminal (M8)
2. Positive battery terminal (M8)
3. Battery case handle

## MOUNTING INSTRUCTIONS

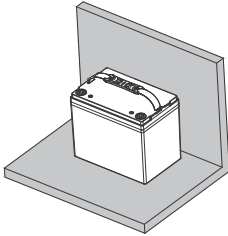

YES

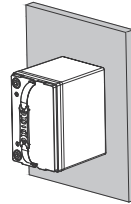

NO

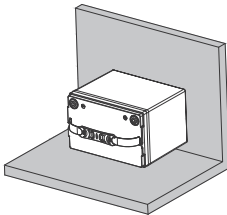

NO

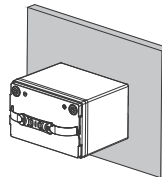

NO

Place the battery smoothly with the positive and negative poles facing up.

Do not mount the battery on the wall without the mounting bracket.

Maximum of 4 batteries can be connected in parallel.



# CONFIGURATION

**(i) NOTE DAMAGE HAZARD**

## WIRING

Parallel connection-1:

**Positive**

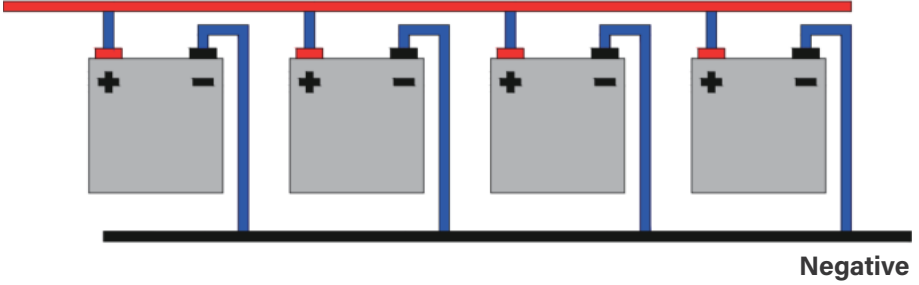

Parallel connection-2:

**Positive**

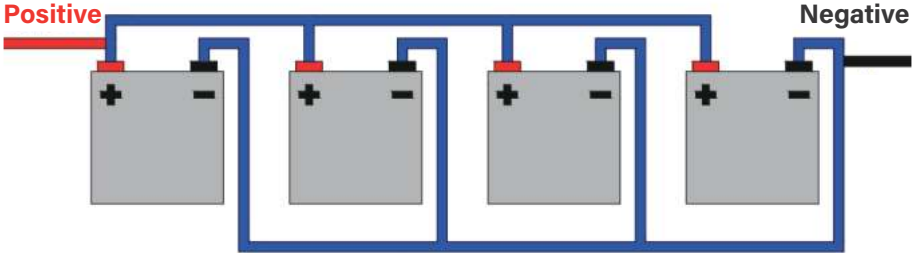

## **WARNING! DAMAGE HAZARD**

- Refer the connection diagram to connect battery pack in parallel.
- A maximum of 4 batteries in parallel.
- Fully charge each battery pack separately or the max difference voltage between battery packs is within 1V. When multiple batteries are used in parallel, each individual battery should be fully charged or fully discharged separately to ensure that the voltage difference between each battery pack is as small as possible, and then connected in parallel.
- When multiple battery packs are used in parallel, the total charging surge current of the charger may be applied to a single battery pack. It should be ensured that the total charging surge current of the charger does not exceed the maximum charging surge current of a single battery.
- When connecting battery with cables, make sure not to reverse the polarity of the connections. If it is indeed connected incorrectly, the BMS may be damaged. It needs to be retested and qualified before use.
- Battery parallel precautions:

It is strictly prohibited to connect battery packs of different brands, models and specifications in parallel. Battery cables connected in parallel must have the same length and specifications, and the busbar must have sufficient current carrying capacity.

## **CHARGING**

### **WARNING! DAMAGE HAZARD**

- Do not hot-swap the battery pack connection with RV system unless necessary, it will cause surge current.
- Do not charge with higher current than recommended value. It will damage the battery electrical, mechanical and safety performance and could lead to heat generation or leakage.
- Charging current should be less than maximum charging current.
- Charging voltage should be less than 14.4V. Charging beyond this absolute maximum voltage is strictly prohibited.
- The battery should be charged within the charging temperature range.
- Reverse charging is prohibited.

- The battery should be connected correctly and the polarity to be confirmed before wiring.
- In case the battery is connected improperly, the battery cannot be charged.
- The reverse charging may cause damaging to the battery which may lead to degradation of battery performance and damage the battery safety and could cause heat generation or leakage.

## **DISCHARGING**

- The battery should be discharged at less than the maximum discharge current. High discharging current may reduce the discharging capacity significantly or cause over-heat.
- The battery should be discharged within the discharging temperature range.
- To prevent over-discharging, the battery should be charged periodically to keep about 40-50% charge.
- Over-discharging may cause loss of battery performance, characteristics or battery functions.
- The charger prevent the battery to be further discharged beyond the end-of-discharge voltage.

## **CLEANING**

---

The lithium batteries are maintenance-free. Occasionally clean the product with a damp cloth.

# STORAGE

The battery is in transit, and SOC is about 30% by air shipment, about 50 % SOC by sea shipment. The storage environment requirement is as follows:

Storage Temperature	-22 ~ 131°F 90%RH Max	Less than 1 month
	14 ~ 113°F 90%RH Max	More than 3 months
Recommended Storage Temperature	50 ~ 95°F 85%RH Max	the battery life would be reduced if battery is stored in high temperature.

If you want to store it for a long time (more than 3 months), store it in an environment where the temperature ranges from 50°F to 95°F @ 85% RH Max and does not contain corrosive gases. Charge and discharge it every 3 months and keep the SOC between 40-50%.

# TROUBLESHOOTING

Problem	Possible cause	Suggested remedy
Battery cannot discharge	<ul style="list-style-type: none"> <li>• Protection against over-temperature. (cell temperature is higher than 149°F)</li> <li>• Protection against under voltage protection.</li> <li>• Protection against over current protection.</li> <li>• Battery output terminal is short circuit.</li> <li>• System failure.</li> </ul>	<ul style="list-style-type: none"> <li>• Regulate battery pack discharge ambient temperature lower than 122°F</li> <li>• Charge battery</li> <li>• RV discharge power is over load, should decrease discharge power</li> <li>• Check the connection wire and try charge battery</li> <li>• Shutdown system and check the RV system function</li> </ul>

Problem	Possible cause	Suggested remedy
Battery cannot charge	<ul style="list-style-type: none"> <li>• Protection against over voltage protection.</li> <li>• Protection against over current protection.</li> <li>• Protection against over-temperature or under-temperature.(cell temperature is lower than 32°F or higher than 131°F)</li> <li>• Battery output terminal is short circuit System failure.</li> </ul>	<ul style="list-style-type: none"> <li>• Disconnect the charger and load discharge current for few minutes. Try again to charge the battery.</li> <li>• Charge is abnormal and the output current is over value.</li> <li>• Regulate battery pack charge ambient temperature from 41°F to 113°F. If charged in freezing weather, need to wait until it is heated up to 37.4°F by inner heater.</li> <li>• Check the connection wire and try charge battery.</li> <li>• Shutdown system and check the RV system function.</li> </ul>

## DISPOSAL



Recycling products with batteries, rechargeable batteries and light sources: Remove any batteries, rechargeable batteries, and light sources before recycling the product. Return defective or used batteries to your retailer or dispose of them at collection points. Do not dispose of any batteries, rechargeable batteries, and light sources with general household waste. If you wish to finally dispose of the product, ask your local recycling center or specialist dealer for details about how to do this in accordance with the applicable disposal regulations. The product can be disposed free of charge.



Recycling packaging material: Place the packaging material in the appropriate recycling waste bins wherever possible.

# TECHNICAL DATA

For the below table, all items are minimum performance values and “must have” UNLESS indicated otherwise.

## BATTERY TECHNICAL PARAMETERS

Project Specifications	Standard Parameters	Remarks
Battery model	12.8V 100Ah	The battery supports a maximum of four parallel batteries
Battery type	LFP battery	
Nominal voltage	12.8V	
Nominal capacity	100Ah	77±3.6°F, 0.5C Charge, 0.5C Discharge
Minimum capacity	100Ah	77±3.6°F, 0.5C Charge, 0.5C Discharge, Factory capacity
Nominal energy	1280Wh	
Nominal charging voltage	14.4V	
Nominal discharging cutoff voltage	11.2V	
Standard charging current	50A	
Maximum charging current	100A	
Standard discharge current	50A	
Continuous discharge current	100A	
Maximum discharge current	100A	
Shell material	Plastic shell	
Weight	About 24.3lb/11.0kg	Net battery weight
Initial internal resistance	≤50mΩ	New battery within 3 months, ACIR, 1000HZ
Monthly self-discharge rate	≤5%	Standard charged to 100% SOC, and storage for 28 days at 77±3.6°F

Overall dimensions	10.2x6.6x8.3in /260x168x212mm	Length x Width x Height (Box size, without handle, terminal)
Delivery voltage	12~14.0V	30~60% SOC
Cycle life (times)(77±3.6°F)	≥3200 capacity retention: ≥80%	a) At room temperature, continue charging at 50A constant current until the battery voltage is 14.4V, and charge at constant voltage until the current is 0.05C, Let stand 2h; b) Discharged at 50A to the cut-off voltage 11.2V at room temperature, Let stand 3h; c) Repeating steps of a) ~ b), until the discharge capacity reached the 80% of rated capacity, the number of cycles completed was defined as the battery cycle life.
Communication mode	/	
Charging temperature	30A	32~50°F / 0~10°C
	50A	50~68°F / 10~20°C
	100A	68~104°F / 20~40°C
	30A	104~131°F / 40~55°C
Discharge temperature	-4~140°F /-20~60°C	The surface temperature of the cell should not exceed 140°F
Storage temperature	-22~131°F / -30~55°C 90%RH Max	Less than 1 month
	14~113°F / -10~45°C 90%RH Max	More than 3 months
Recommended storage temperature	50~95°F / 10~35°C 85%RH Max	The battery life would be reduced if battery is stored in high temperature.

# BATTERY MANAGEMENT SYSTEM

Function	Test project	Min	Typical	Max	unit
Operation voltage	Voltage range	8.8	/	14.4	V
Operation current	Charging current	/	50	100	A
	Discharge current	/	50	100	A
Over charge protection	Charger voltage (CC/CV)	/	/	14.4	V
	Over charge protection voltage(Cell)	3.72	3.75	3.78	V
	Over charge protection delay time	500	1000	1500	ms
	Over charge protection recovery voltage (Cell)	3.40	3.55	3.60	V
Over discharge protection	Over discharge protection voltage(Cell)	2.12	2.2	2.28	V
	Over discharge protection delay time	500	1000	1500	ms
	Over discharge protection recovery voltage (Cell)	2.6	2.7	2.8	V
	Over discharge protection release conditions	Disconnect load or charge release.			
Over-current charge	Primary charge over current protection value	130	180	230	A
	First stage charge over current delay	500	1000	1500	ms
	Secondary charge over current protection value	/	/	/	A
	Secondary charge over current delay	/	/	/	ms
	Over-current charge release conditions	Disconnect the charger.			



Over-current discharge	Primary discharge over current protection value	700	900	1100	A
	Primary discharge over current protection delay	5	10	15	ms
	Secondary discharge over current protection current value	1400	1800	2200	A
	Secondary discharge over current protection delay	500	1000	1500	μs
	Over-current discharge release	Disconnect load or charge release.			
Discharge high temperature protection	Temperature protection value	158	167	176	°F
	Temperature protection release value	127.4	136.4	145.4	°F
Low temperature protection of discharge	Temperature protection value	/	/	/	°F
	Temperature protection release value	/	/	/	°F
Charging high temperature protection	Temperature protection value	120.2	129.2	138.2	°F
	Temperature protection release value	111.2	120.2	129.2	°F
Charging low temperature protection	Temperature protection value	19.4	28.4	37.4	°F
	Temperature protection release value	28.4	37.4	46.4	°F
High temperature protection of FET(Built-in)	Temperature protection value	179.6	194	208.4	°F
	Temperature protection release value	122	149	176	°F
Balance function	Equalizing opening voltage	3.45	3.50	3.55	V
	Equalize the opening pressure difference	/			mV
	Balance current	150	/	250	mA
Heating function	The charging low temperature protection is turned on, and the battery is in the charging state, and the heating is turned on	100			W
	After low temperature protection release, heat off				

Note: Test should be at temperature 77±3.6°F, and relative humidity 65±20% of surroundings.

## **AFTER-SALE SERVICE**

---

Customer Service: 1-800-850-9978

Order Support: [sales@sunrichenergy.com](mailto:sales@sunrichenergy.com)

Tech Support: [info@sunrichenergy.com](mailto:info@sunrichenergy.com)

Address(Office & Warehouse): 2050 S Carlos Ave, Ontario, CA 91761 United States

Website: [www.sunrichenergy.com](http://www.sunrichenergy.com)



SUNRICH ENERGY

Making solar power accessible and  
affordable across America.