

# MEGA 100 SLIM

Monocrystalline Solar Panel

## 100W

Maximum Power Output

## 32 CELLS

Monocrystalline Module

## 0~+5W









Positive Power Tolerance

## 19.2%

Maximum Efficiency



## FEATURES

-  16 bus bars solar cell configuration
-  Lightweight anodized aluminum frame
-  Plug and play junction box
-  High transmission, AR (anti-reflective) coated tempered glass
-  Industry standard quick connect cables (Solar Connectors) work in series or in parallel
-  Excellent low light performance on cloudy days, mornings and evenings
-  Highly reliable due to stringent quality control (Over 30 in-house tests (UV, TC, HF, and many more), PID resistant, 100% EL double inspection)
-  Certified to withstand challenging environmental conditions (2400 Pa wind load, 5400 Pa snow load, 35 mm hail stones at 97 km/h)

## INSTALLATION

Easy installation and handling for various applications (high-end off-grid and mobile applications).

Pre-drilled holes compatible with ground mounts, Z brackets, pole mounts and tilt mounts.

Compatible with on-grid and off-grid inverters.

## WARRANTY

25-year limited warranty on output power.

\* (Please refer to product warranty for details)

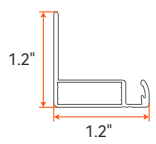
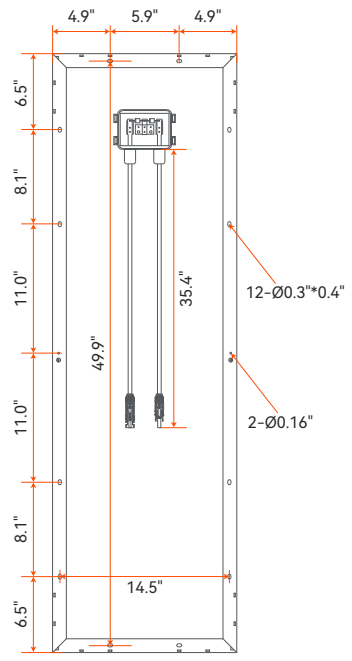
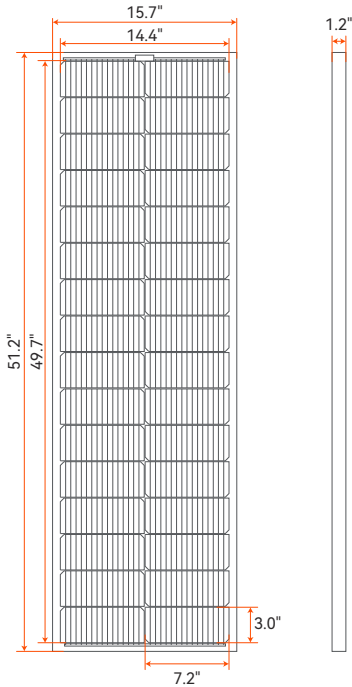

### ELECTRICAL DATA (STC)

Peak Power Watts-PMAX (Wp)	100 W
Power Output Tolerance-PMAX (W)	0~+5 W
Maximum Power Voltage-VMPP (V)	18.1 V
Maximum Power Current-IMPP (A)	5.52 A
Open Circuit Voltage-VOC (V)	22.1 V
Short Circuit Current-ISC (A)	5.96 A
Maximum System Voltage	1000 VDC
Maximum Series Fuse Rating	10 A
Module Efficiency $\eta$ m (%)	19.2 %

STC: Irradiance 1000 W/m<sup>2</sup>, Cell Temperature 25 °C, Air Mass AM = 1.5

### MECHANICAL DATA

Solar Cells	Monocrystalline 7.2 × 3.0 in (182 × 77 mm)
Module Dimensions	51.2 × 15.7 × 1.2 in (1300 × 400 × 30 mm)
Cell Orientation	32 cells (2 × 16)
Weight	13.7 lb (6.2 kg)
Glass	3.2 mm (0.13 in), High Transmission, AR Coated Tempered Glass
Backsheet	White
Connector	Solar Connectors
Frame	Anodized Aluminum Alloy
Junction Box	IP 67 rated
Cables	Photovoltaic Technology Cable 4.0 mm <sup>2</sup> (#12 gauge), 35.4 in (900 mm) Length

### TEMPERATURE RATINGS

Operating Temperature	-40°C ~ +85°C
Nominal Module Operating Temperature (NMOT)	45°C ± 2°C
Temperature Coefficient of PMAX	-0.39%/°C
Temperature Coefficient of VOC	-0.29%/°C
Temperature Coefficient of ISC	0.05%/°C

### CURVE CHARACTERISTICS

